

IRMIN TR HE.

Align or cross. A line of light, easily adaptable according to need. 180° rotation and a huge selection of beam angles make it possible. Perfect for any retail setting. The high-performance lens and maximum efficiency complete the picture.

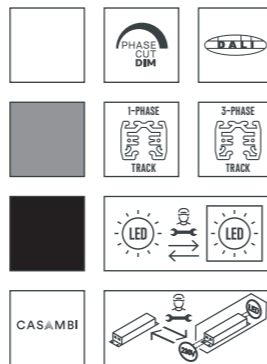
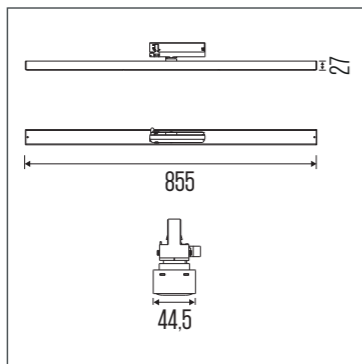

Adjustability : 180° rotational
 CCT [K] : 2700K, 3000K, 4000K
 CRI [Ra] : [Ra] >90
 Chromaticity Tolerance : 3
 Luminous Flux [lm] : max. 5300lm
 System Power [W] : 43W
 System Efficiency [lm/W] : max. 140lm/W
 Electrical Safety Class : Class II

Optic : Lens - Double Assymetric, 30°, 55°, 90°, 105° and 32° x 75°
 Mains Voltage [VAc] : 220-240V / 50-60Hz
 Ambient Temperature [°C] : 35°C
 Ingress Protection [IP] : IP20
 Net Weight [kg] : 1,30kg
 Warranty [Y] : 5 years

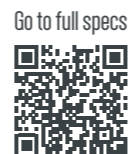

IRMIN TR HE OPAL.

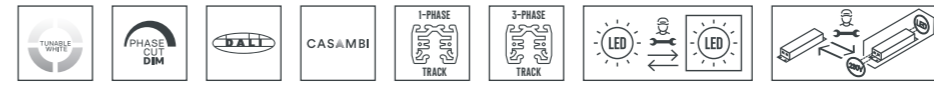
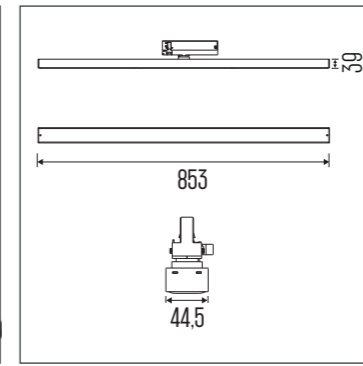

Adjustability : 180° rotational
 CCT [K] : 2700K, 3000K, 4000K
 CRI [Ra] : [Ra] >90
 Chromaticity Tolerance : 3
 Luminous Flux [lm] : max. 4500lm
 System Power [W] : 40W
 System Efficiency [lm/W] : max. 113lm/W
 Electrical Safety Class : Class II

Optic : PC Diffuser 110°
 Mains Voltage [VAc] : 220-240V / 50-60Hz
 Ambient Temperature [°C] : 35°C
 Ingress Protection [IP] : IP20
 Net Weight [kg] : 1,40kg
 Warranty [Y] : 5 years

Go to full specs



IRMIN TR HE LOUVRE.

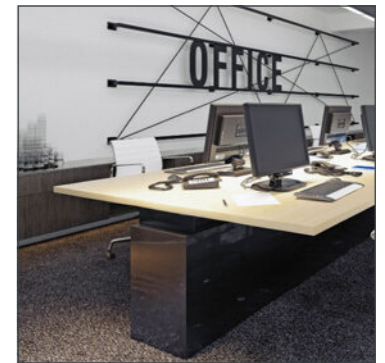
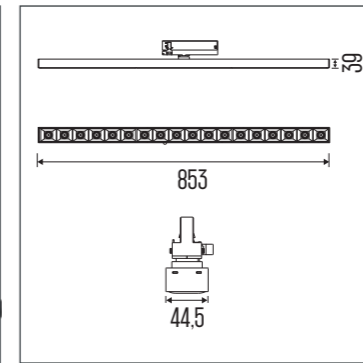

Adjustability : 180° rotational
 CCT [K] : 3000K, 4000K
 CRI [Ra] : [Ra] >90
 Chromaticity Tolerance : 3
 Luminous Flux [lm] : max. 4800lm
 System Power [W] : 42W
 System Efficiency [lm/W] : max. 120lm/W
 Electrical Safety Class : Class II

Optic : PC Lens / Louvre (white or black) 55°, 80°
 Mains Voltage [VAc] : 220-240V / 50-60Hz
 Ambient Temperature [°C] : 35°C
 Ingress Protection [IP] : IP20
 Net Weight [kg] : 1,40kg
 Warranty [Y] : 5 years

Go to full specs

